



UNRIVALED PERFORMANCE, UNBEATABLE VALUE



WaveSurfer 4000HD



200 MHz - 1 GHz
High Definition Oscilloscopes

-  **Highest Resolution** HD4096 technology, 12 bits all the time
-  **More Capability** than you imagined
-  **Comprehensive Probe Support** Over 30 probes in 9 categories

Highest Resolution



High Signal to Noise Input Amplifiers

High Sample Rate 12-bit ADC's

HD
4096

Low Noise System Architecture

12 bits **all the time.**

More Capability



Spectrum Analysis

LabNotebook

MAUI
with **OneTouch**

Frequency Counter

HD
4096

170,000 wfms/sec

AFG

Protocol Analysis

16 ch History Mode

MSO 12.1" Touch **Pass/Fail**

Comprehensive Probe Support





Unrivaled Performance, Unbeatable Value

WaveSurfer 4000HD extends Teledyne LeCroy's leadership in **High Definition Oscilloscopes** with a bright, 12.1" touch screen display, performance without compromise, and **price points that fit your budget.**

12 bits all the time.



WaveSurfer 4000HD

HD4096 TECHNOLOGY - 12 BITS ALL THE TIME

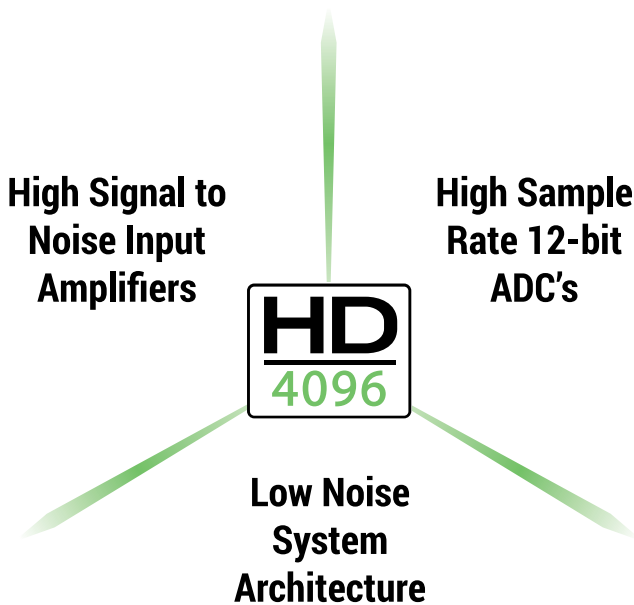

Teledyne LeCroy high definition 12-bit oscilloscopes use unique HD4096 technology to provide superior and uncompromised measurement performance:

- 12-bit ADCs with high sample rates
- High signal-to-noise amplifiers
- Low noise system architecture (to 1 GHz)

Oscilloscopes with HD4096 technology have higher resolution than conventional 8-bit oscilloscopes (4096 vs. 256 vertical levels) and low noise for uncompromised measurement performance. The 12-bit ADCs support capture of fast signals and oscilloscope bandwidth ratings up to 1 GHz, while 5 GS/s sample rate ensures the highest measurement accuracy and precision. The high performance input amplifiers deliver pristine signal fidelity, and the low-noise system architecture provides an ideal signal path to ensure that signal details are delivered accurately to the oscilloscope display – 16x closer to perfect.

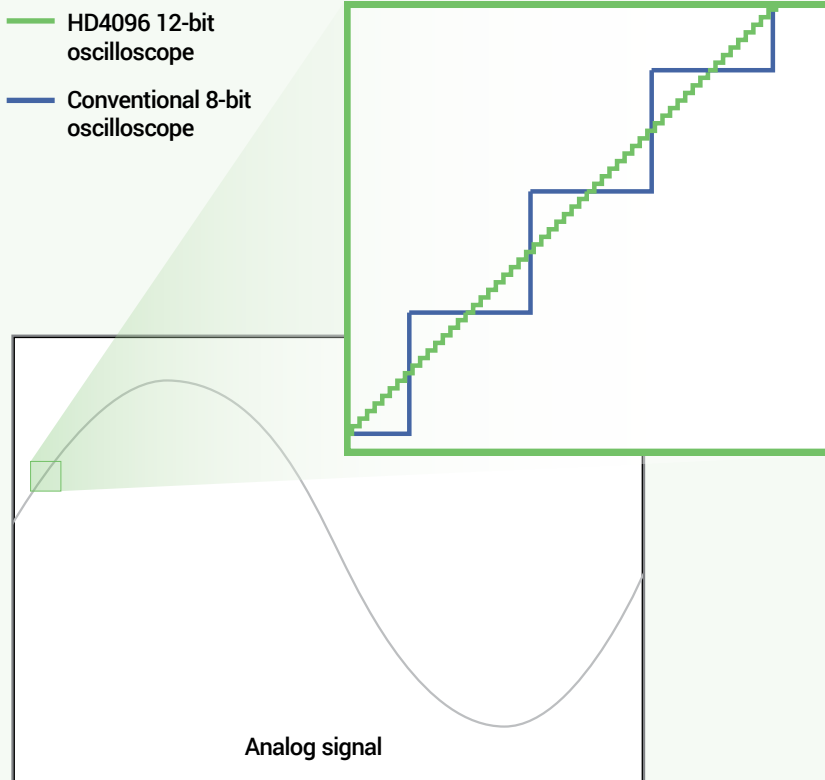

16x Closer to Perfect

16x more resolution

HD4096 technology provides 12 bits of vertical resolution – 16x more resolution than conventional 8-bit oscilloscopes. The 4096 discrete vertical levels reduce the quantization error compared to 256 vertical levels. This improves the accuracy and precision of the signal capture and increases measurement confidence.

EXPERIENCE THE DIFFERENCE



Experience HD4096 accuracy, detail, and precision and never use an 8-bit oscilloscope again. Whether the application is general-purpose design and debug, high-precision analog sensors, power electronics, automotive electronics, mechatronics, or other specialized applications, the HD4096 technology provides unsurpassed confidence and measurement capabilities.

Clean, crisp waveforms

When compared to waveforms acquired and displayed using conventional 8-bit oscilloscopes, waveforms captured with HD4096 12-bit technology are dramatically crisper and cleaner, and are displayed more accurately. Once you see a waveform acquired with HD4096 technology, you will not want to go back to using a conventional 8-bit oscilloscope.

More signal details

16x more resolution provides more signal detail. This is especially helpful for analyzing wide dynamic range signals where very small amplitude signal details must be viewed. 12-bit acquisitions combined with the oscilloscope's vertical and horizontal zoom capabilities provide unparalleled insight into system behaviors and problems.

Unmatched measurement precision

HD4096 technology delivers measurement precision several times better than conventional 8-bit oscilloscopes. Higher oscilloscope measurement precision results in better ability to assess corner cases and design margins, perform root cause analysis, and create the best possible solution for any discovered design issue.

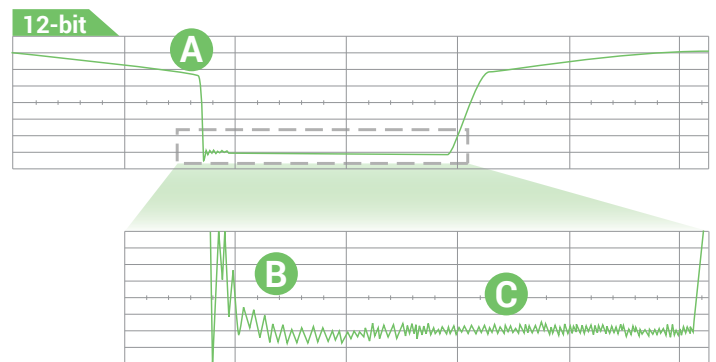
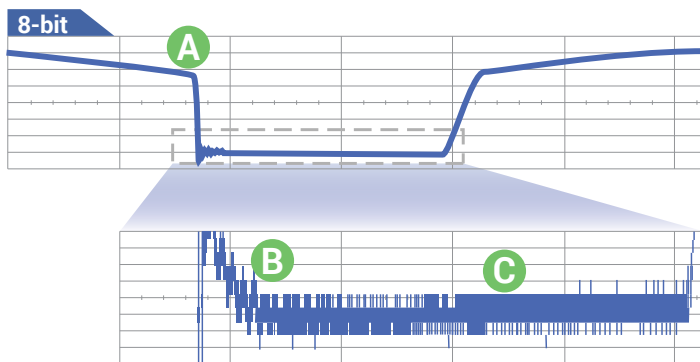

- A Clean, crisp waveforms** | Thin traces show the actual waveform with minimal noise interference.
- B More signal details** | Waveform details can now be clearly seen on an HD4096 12-bit oscilloscope.
- C Unmatched measurement precision** | Measurements are more precise and not affected by quantization noise.



Protocol Analysis with Serial Trigger and Decode

- Intuitive, color-coded overlays make it easy to understand serial data information
- Powerful, conditional data triggering capabilities
- Interactive decode table summarizes results of two different protocol decodes
- Touch a row in the table to automatically zoom and display the selected packet
- Search and conditional filtering

Index	Time	Protocol	Message	Data	CRC	Status
▶ 11	323.943 μs	SSPI	0x43	0x43		
▶ 12	419.72 μs	UART	254	0xfe		
▶ 13	422.595 μs	SSPI	0x72	0x72		
▶ 14	521.247 μs	SSPI	0x6f	0x6f		
▶ 15	529.70 μs	UART	254	0xfe		

Logic Analysis with 16-channel Mixed Signal Capability

- Simultaneously view, measure, and analyze 4 analog and 16 digital channels
- Dedicated digital logic port does not consume analog channels
- Analog and digital channels can be incorporated into a single pattern trigger
- Find anomalies in digital waveforms using WaveScan, trends, statistics, and histicons



MAUI with OneTouch

- Most unique touch screen features on any oscilloscope
- Drag-and-drop to dramatically reduce setup time
- All common operations can be performed with one touch

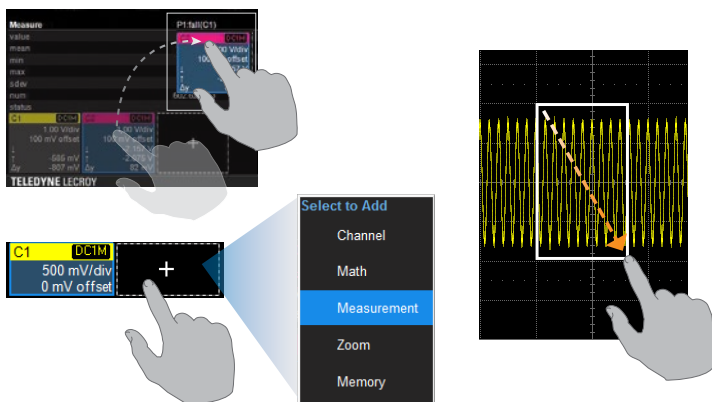

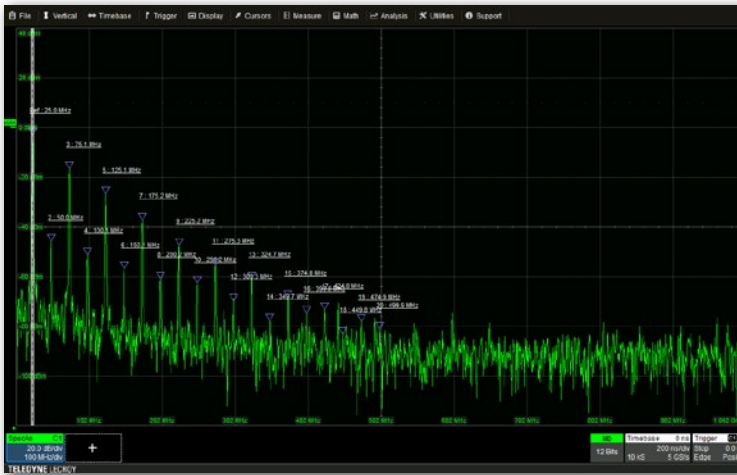

Spectrum Analyzer

- Spectrum analyzer style controls
- Automatically identify and mark peak frequencies, fundamental frequencies, and harmonics
- Easily make measurements with reference and delta markers

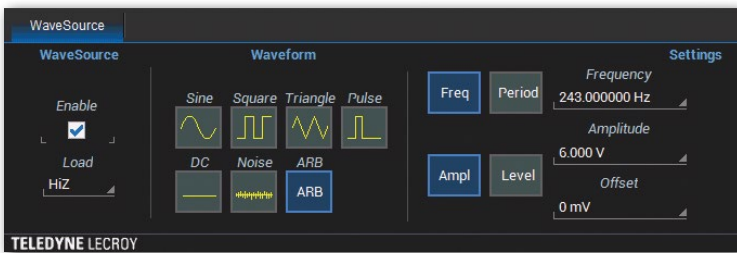

Built-in Waveform Generator

- Frequencies of up to 25 MHz
- Wide variety of waveform sources available
- Saved waveforms can be uploaded to oscilloscope to generate arbitrary waveforms



DVM and Frequency Counter

- 4-digit digital voltmeter, 5-digit frequency counter
- Works with any channel; measurements update even when system is not triggering
- Set voltage readings to DC, DC RMS, or AC RMS

The DVM license key can be downloaded at no charge from teledynelecroy.com/ws4000hd/redeemdvm

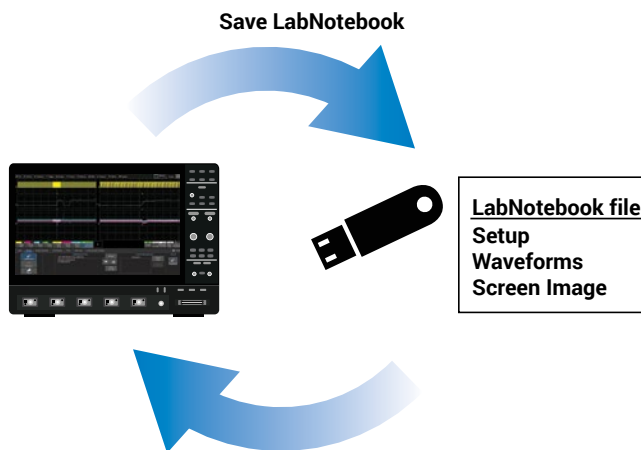

LabNotebook

- Store all setups, waveforms, and screen image in a single LabNotebook file
- Add descriptive notes to LabNotebooks, or mark up screen images
- Recall (“Flashback”) LabNotebooks to restore oscilloscope to past state—including all setups, waveforms, and table data
- Extract component files from .LNB format files, or append other files to .LNB

To learn more about the capabilities of the WaveSurfer 4000HD, see the Oscilloscope Features, Options, and Accessories catalog cdn.teledynelecroy.com/files/pdf/scope-options-accessories-catalog-wavesurfer.pdf

Over 30 probes
in 9 categories

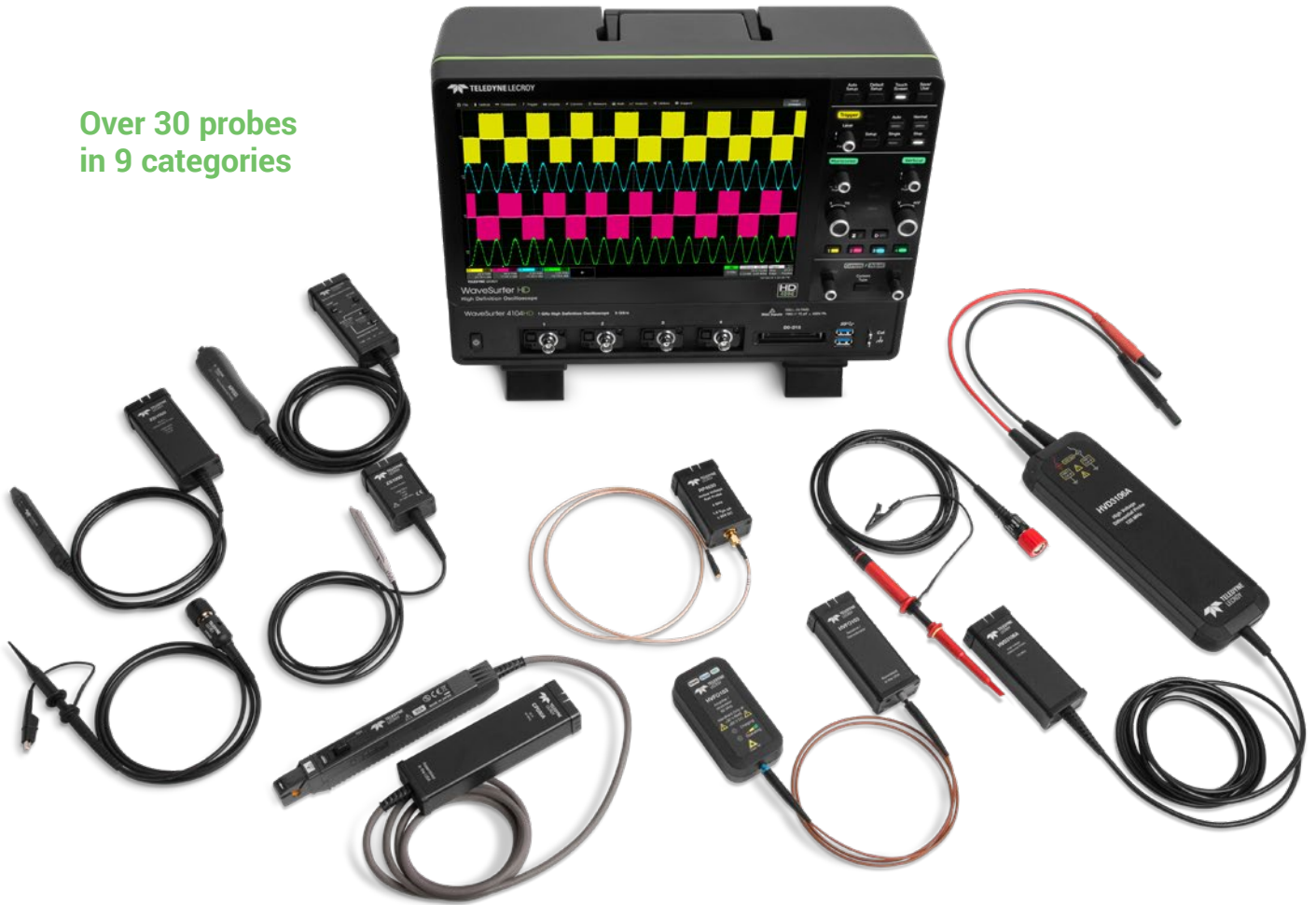

Active Power Rail Probe

Active Voltage Probes

Current Probes



RP4030

- Large (30 V) built-in offset, low noise
- Perfect for low impedance power rails
- Solder-in & U.FL connections



ZS1000, ZS1000-QUADPAK ZS1500, ZS1500-QUADPAK

- Low 0.9 pF input capacitance
- High input impedance (1 M Ω)
- Low cost



CP030, CP030-3M, CP030A CP031, CP031A CP150, CP150-6M CP500, DCS025

- Peak currents up to 700 A
- Sensitivities to 1 mA/div
- Bandwidth up to 100 MHz

Differential Probes



**ZD1500, ZD1000,
ZD500, ZD200
AP033**

- High CMRR, high bandwidth, low noise
- 1 pF capacitance, wide dynamic range
- Series/shunt voltage measurement

High Voltage Differential Probes



**HVD3102A, HVD3106A (1 kV)
HVD3206A (2 kV)
HVD3605A (6 kV)**

- 1, 2, or 6 kV common-mode ratings
- Excellent CMRR (65 dB at 1 MHz)
- 1% gain accuracy

High Voltage Passive Probes



**HVP120
PPE4KV, PPE5KV, PPE6KV**

- 1 kV to 6 kV ratings
- Safe and easy probing accessories
- Sense pin for automatic scaling

High Voltage Fiber Optically-isolated Probes



HVFI013

- 35 kV common-mode rating
- Highest possible CMRR (140 dB)
- Ideal for gate-drive measurements

Passive Probes



PP019, PP026

- Rated for 500 V
- Sense pin for automatic scaling
- High input impedance of 10 MΩ

Probe Adapters



TPA10

- Supports TekProbe interface level II
- Configure power and offset control
- Supports wide variety of Tek probes

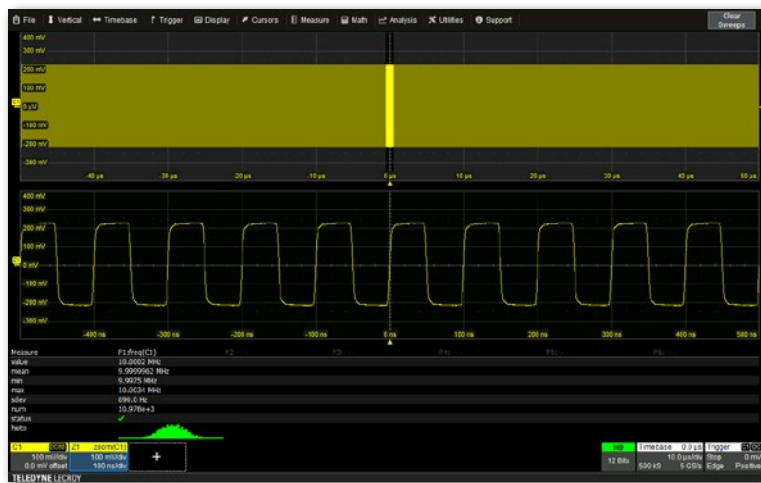
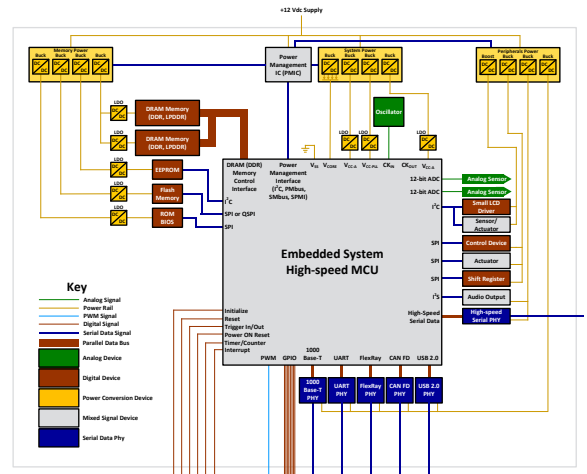
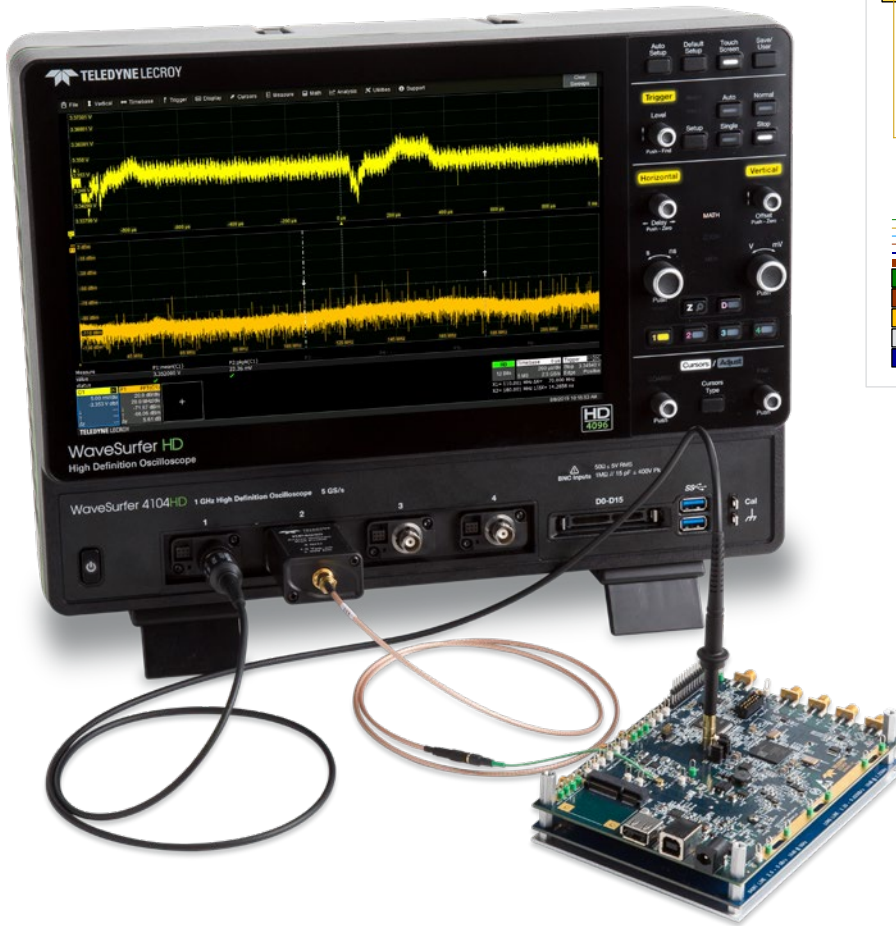

Clock Analysis

- Capture long records to build statistics faster
- All-instance measurements measure every clock edge in any acquisition length
- Trend values over time
- Histograms show statistical distribution

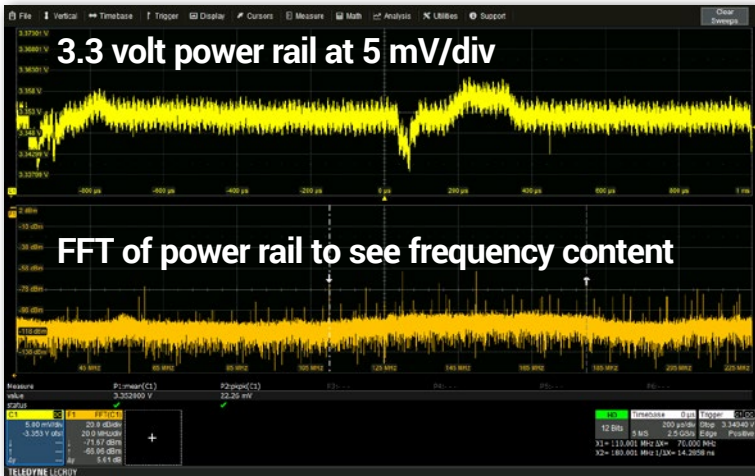

Power Rail Analysis

- 12-bit resolution and low noise clearly shows small signal details in power rails
- FFT or Spectrum Analyzer determines root cause of high noise events
- Built-in high offset capability permits native probing of power rails

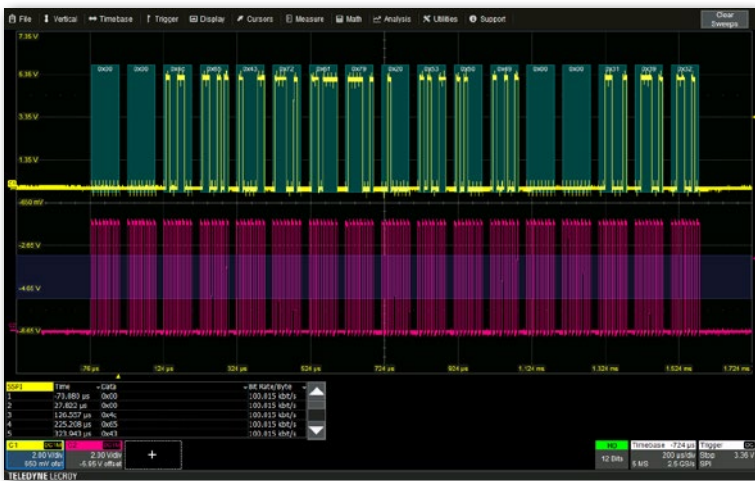

Protocol Analysis

- Trigger on protocol elements or specific DATA patterns using powerful conditional DATA triggering
- Highly adaptable ERROR frame triggering isolates protocol errors
- Combine UART/SPI bytes into single “message frame” to trigger on proprietary protocols
- Use Search and Zoom to correlate protocol events to other embedded signals



Power Analysis

- Measure and analyze operating characteristics of power conversion circuits
- Identify turn-on and turn-off transitions using color-coded overlays
- Automatically calculate switching device measurements
- Measure input/output power and input harmonics



Key Attributes

- | | | |
|--|---|--|
| 1. 12.1" 1280 x 800 capacitive touch screen display | 6. ProBus input supports over 30 probes in 9 product categories | 9. WaveSource Arbitrary Waveform Generator |
| 2. Buttons/indicators color-coded to associated waveform on display | 7. Mixed Signal capability with 16 channel dedicated digital logic port | 10. HDMI output |
| 3. MAUI with OneTouch user interface for intuitive and efficient operation | 8. USB 3.1 ports for easy connectivity | 11. USBTMC over USB 2.0 for data offload |
| 4. HD4096 Technology - 12 bits all the time | | |
| 5. Use cursors and adjust settings without opening a menu | | |



WaveSurfer 4024HD

WaveSurfer 4034HD

WaveSurfer 4054HD

WaveSurfer 4104HD

Vertical - Analog Channels

Analog Bandwidth @ 50 Ω (-3 dB)	200 MHz	350 MHz	500 MHz	1 GHz
Rise Time (10–90%)	1.75 ns	1 ns	700 ps	450 ps
Input Channels	4			
Vertical Resolution	12 bits			
Effective Number of Bits (ENOB)	8.7	8.6	8.5	8.3
Vertical Noise Floor (rms, 50 Ω)				
1 mV/div	65 μ V	70 μ V	90 μ V	125 μ V
2 mV/div	65 μ V	70 μ V	90 μ V	125 μ V
5 mV/div	65 μ V	70 μ V	90 μ V	125 μ V
10 mV/div	70 μ V	75 μ V	95 μ V	130 μ V
20 mV/div	95 μ V	95 μ V	115 μ V	160 μ V
50 mV/div	160 μ V	175 μ V	210 μ V	280 μ V
100 mV/div	270 μ V	290 μ V	350 μ V	465 μ V
200 mV/div	960 μ V	925 μ V	1.10 mV	1.65 mV
500 mV/div	1.60 mV	1.75 mV	2.10 mV	2.75 mV
1 V/div	2.70 mV	2.90 mV	3.50 mV	4.70 mV
Sensitivity	50 Ω: 1 mV–1 V/div, fully variable; 1 MΩ: 1 mV–10 V/div, fully variable			
DC Vertical Gain Accuracy (Gain Component of DC Accuracy)	$\pm 0.5\%$ FS, offset at 0 V			
Channel-Channel Isolation	60 dB	60 dB up to 200 MHz 50 dB up to 350 MHz	60 dB up to 200 MHz 50 dB up to 500 MHz	60 dB up to 200 MHz 50 dB up to 500 MHz 40 dB up to 1 GHz
Offset Range	50 Ω: 1 mV to 4.95 mV: ± 1.6 V; 5 mV to 9.9 mV: ± 4 V; 10 mV to 19.8 mV: ± 8 V; 20 mV to 1 V: ± 10 V 1 MΩ: 1 mV to 4.95 mV: ± 1.6 V; 5 mV to 9.9 mV: ± 4 V; 10 mV to 19.8 mV: ± 8 V; 20 mV to 100 mV: ± 16 V; 102 mV to 198 mV: ± 80 V; 200 mV to 1 V: ± 160 V; 1.02 V to 10 V: ± 400 V			
DC Vertical Offset Accuracy	$\pm(1.0\%$ of offset setting + 0.5% FS + 0.02% of max offset + 1 mV)			
Maximum Input Voltage	50 Ω : 5 Vrms, 1 M Ω : 400 V max (DC + Peak AC \leq 10 kHz)			
Input Coupling	1 M Ω : AC, DC, GND; 50 Ω : DC, GND			
Input Impedance	50 Ω : $\pm 2.0\%$; 1 M Ω : $\pm 2.0\%$ 15 pF			
Bandwidth Limiters	20 MHz	20 MHz, 200 MHz	20 MHz, 200 MHz	20 MHz, 200 MHz
Rescaling	Electrical: Volts, Amps			

Horizontal - Analog Channels

Acquisition Modes	Real-time, Roll, Average, Sequence (Segmented Memory up to 1000 segments with 1 μ s min. intersegment time)
Timebases	Internal timebase common to 4 input channels
Time/Division Range	500 ps/div to 100 s/div
Clock Accuracy	± 2.5 ppm + 1.0 ppm/year from calibration

Acquisition - Analog Channels

Sample Rate (Single-Shot)	2.5 GS/s on 4 Ch, 5 GS/s on 2 Ch
Standard Memory (4 Ch / 2 Ch)	12.5 Mpts / 25 Mpts
Averaging	Summed averaging to 1024 sweeps

Vertical, Horizontal, Acquisition - Digital Channels (WS4KHD-MSO option only)

Input Channels	16 Digital Channels
Threshold Groupings	Pod 2: D15 to D8, Pod 1: D7 to D0
Threshold Selections	TTL (+1.4 V), 5 V CMOS (+2.5 V), ECL (-1.3 V) or User Defined
Maximum Input Voltage	± 30 V Peak
Threshold Accuracy	$\pm(3\%$ of threshold setting + 100 mV)
Input Dynamic Range	± 20 V
Minimum Input Voltage Swing	500 mVpp
Input Impedance (Flying Leads)	100 k Ω 5 pF
Maximum Input Frequency	125 MHz
Sample Rate	500 MS/s
Record Length	12.5 Mpts - 16 Channels
Minimum Detectable Pulse Width	4 ns
Channel-to-Channel Skew	$\pm(1$ digital sample interval)
User-defined Threshold Range	± 10 V in 20 mV steps

WaveSurfer 4024HD

WaveSurfer 4034HD

WaveSurfer 4054HD

WaveSurfer 4104HD

Triggering System

Modes	Normal, Auto, Single, and Stop			
Sources	Any input channel, Ext, Ext/5, or Line; slope and level unique to each source (except Line trigger)			
Coupling	DC, AC, HFRrej, LFRrej			
Hold-off	From 10 ns up to 20 s or from 1 to 100,000,000 events			
Pre-trigger Delay	0 to 100% of full scale			
Post-trigger Delay	0 to 10,000 divisions			
Internal Trigger Level Range	±4.1 div from center (typical)			
External Trigger Level Range	Ext (±0.610 mV); Ext/5 (±3.05 V)			
Maximum Trigger Rate	175,000 waveforms/second			
Trigger Sensitivity with Edge Trigger (Ch 1–4)	0.9 division @ 10 MHz	0.9 division @ 10 MHz 1.0 divisions @ 200 MHz	0.9 division @ 10 MHz 1.0 divisions @ 200 MHz	0.9 division @ 10 MHz 1.0 divisions @ 200 MHz
Trigger Types	Edge, Width, Logic (Pattern), TV (NTSC, PAL, SECAM, HDTV - 720p, 1080i, 1080p), Runt, Slew Rate, Interval (Signal or Pattern), Dropout, Qualified (State or Edge). External input supports Edge trigger only.			

Low Speed Serial Protocol Triggering (Optional)

I2C, SPI (SPI, SSPI, SIOP), UART-RS232, CAN1.1, CAN2.0, CAN FD, LIN, FlexRay

Measure, Zoom, and Math Tools

Measurement Parameters	Up to 6 parameters can be calculated at one time on any waveforms, selected from the following list of measurements: Amplitude, Area, Base, Delay, Duty Cycle, Fall Time (90%–10%), Fall Time (80%–20%), Frequency, Maximum, Mean, Minimum, Overshoot+, Overshoot-, Peak-Peak, Period, Phase, Rise Time (10%–90%), Rise Time (20%–80%), RMS, Skew, Standard Deviation, Top, Width+, Width-. Statistics and histicons can be added to measurements. Measurements can be gated.
Zooming	Use front panel QuickZoom button, or Rectangle-Zoom using touch screen or mouse.
Math Functions	Up to 2 math functions can be calculated at one time on any waveforms, selected from the following list of operations: Sum, Difference, Product, Ratio, Absolute Value, Average, Derivative, Enhanced Resolution, Envelope, Floor, Integral, Invert, Reciprocal, Rescale, Roof, SinX/x, Square, Square Root, Trend, Zoom and FFT (with Power Spectrum output; Rectangular, VonHann and FlatTop windows).

Display System

Size	12.1" widescreen capacitive touch screen
Resolution	1280 x 800 pixels

Probes

Standard Probes	PP019 (5 mm), 1 per channel	PP026 (5 mm), 1 per channel
Probing System	BNC and Teledyne LeCroy ProBus for active voltage, current, and differential probes	

Connectivity

Ethernet Port	1 x 10/100BaseT Ethernet interface (RJ45 port)
Removable Storage	1 Micro SD port, 16 GB Micro SD card installed standard
USB Host Ports	2 front USB 3.1 Gen1 ports, 2 back USB 2.0 ports
USB Device Port	1 USBTMC over USB 2.0 port
External Monitor Port	1 HDMI port, supports up to 1280 x 800 pixels
Remote Control	Microsoft COM Automation or LeCroy Remote Command Set
Network Communication Standard	VICP or VXI-11, LXI compatible

Power Requirements

Voltage	100 to 240 VAC ±10% @ 50 to 60 Hz ±10%; 100 to 120 VAC ±10% @ 400 Hz ±5%; automatic AC voltage selection
Nominal Power Consumption	90 W / 90 VA
Max Power Consumption	150 W / 150 VA

Environmental

Temperature	Operating: 0 °C to +50 °C; Non-operating: –30 °C to +70 °C
Humidity	Operating: 5% to 90% RH (non-condensing) at ≤30 °C, upper limit derates to 50% RH (non-condensing) at +50 °C; Non-operating: 5% to 95% relative humidity (non-condensing) as tested per MIL-PRF-28800F
Altitude	Operating: 3,048 m (10,000 ft) max at ≤ 25 °C; Non-operating: up to 12,192 meters (40,000 ft)

Size and Weight

Dimensions (HWD)	10.7" H x 14.9" W x 6.3" D (273 mm x 380 mm x 160 mm)
Weight	11.7 lbs (5.3 kg)

Certifications

CE Certification	CE compliant, UL and cUL listed; conforms to UL 61010-1 (3rd Edition), UL 61010-2-030 (1st Edition), and CAN/CSA C22.2 No. 61010-1-12
UL and cUL Listing	

Warranty and Service

3-year warranty; calibration recommended annually. Optional service programs include extended warranty, upgrades, and calibration services.

WaveSurfer 4024HD

WaveSurfer 4034HD

WaveSurfer 4054HD

WaveSurfer 4104HD

Digital Voltmeter (Optional, available no charge at teledynelecroy.com/ws4000hd/redeemdvm)

Functions	ACrms, DC, DCrms, Frequency
Resolution	ACV/DCV: 4 digits, Frequency: 5 digits
Measurement Rate	100 times/second, measurements update on the display 5 times/second
Vertical Settings Autorange	Automatic adjustment of vertical settings to maximize the dynamic range of measurements

WaveSource Arbitrary Waveform Generator (WS4KHD-FG option only)

General

Max Frequency	25 MHz
Channels	1
Sample Rate	125 MS/s
Arbitrary Waveform Length	16 kpts
Frequency Resolution	1 μ Hz
Vertical Resolution	14 bits
Vertical Range	± 3 V (HiZ); ± 1.5 V (50 Ω)
Waveform Types	Sine, Square, Triangle, Pulse, DC, Noise, ARB, Exponential Fall, Exponential Rise, Ramp, Gaussian, Lorentz, Cardiac, Haversine

Frequency Specification

Sine/Haversine	1 μ Hz - 25 MHz
Square/Pulse	1 μ Hz - 10 MHz
Ramp/Triangular	1 μ Hz - 300 KHz
Exponential Fall/Rise	1 μ Hz - 1 MHz
Gaussian, Lorentz, Cardiac	1 μ Hz - 5 MHz
Noise	25 MHz (-3 dB)
Resolution	1 μ Hz
Accuracy	± 50 ppm, over temperature
Aging	± 3 ppm/year, first year

Output Specification

Amplitude	4 mVpp - 6 Vpp (HiZ); 2 mVpp - 3 Vpp (50 Ω)
Vertical Accuracy	$\pm(0.3$ dB + 1 mV)
Amplitude Flatness	± 0.5 dB

DC Offset

Range (DC)	± 3 V (HiZ); ± 1.5 V (50 Ω)
Offset Accuracy	$\pm(1\%$ of offset value + 3 mV)

Waveform Output

Impedance	50 Ω $\pm 2\%$
Protection	Short-circuit protection

Sine Spectrum Purity

SFDR (Non Harmonic) @1.265 Vpp	
DC-1 MHz	-60 dBc
1 MHz - 5 MHz	-55 dBc
5 MHz - 25 MHz	-50 dBc
Harmonic Distortion @1.265 Vpp	
DC - 5 MHz	-50 dBc
5 MHz - 25 MHz	-45 dBc

Square/Pulse

Rise/Fall time	24 ns (10% - 90%)
Overshoot	3% (typical - 1 kHz, 1 Vpp)
Pulse Width	50 ns minimum
Jitter	500 ps + 10 ppm of period (RMS cycle to cycle)

Ramp/Triangle

Linearity	0.1% of Peak value output (typical - 1 kHz, 1 Vpp, 100% symmetric)
Symmetry	0% to 100%

Product Description	Product Code
WaveSurfer 4000HD Oscilloscopes	
200 MHz, 2.5 GS/s, 4 Ch, 12.5 Mpts/Ch High Definition Oscilloscope with 12.1" capacitive touch screen	WaveSurfer 4024HD
350 MHz, 2.5 GS/s, 4 Ch, 12.5 Mpts/Ch High Definition Oscilloscope with 12.1" capacitive touch screen	WaveSurfer 4034HD
500 MHz, 2.5 GS/s, 4 Ch, 12.5 Mpts/Ch High Definition Oscilloscope with 12.1" capacitive touch screen	WaveSurfer 4054HD
1 GHz, 2.5 GS/s, 4 Ch, 12.5 Mpts/Ch High Definition Oscilloscope with 12.1" capacitive touch screen	WaveSurfer 4104HD

Included with Standard Configurations

±10 passive probes (Qty. 4), Micro SD card (installed), Micro SD card adapter, protective cover, Getting Started Guide, commercial NIST traceable calibration with certificate, power cable for the destination country, 3-year warranty

Multi-Instrument Options

Mixed-Signal Oscilloscope (incl. 16-channel digital leadset, 22 extra large gripper probes, 20 ground extenders, 5 flexible ground leads and license)	WS4KHD-MSO
MSO License (without accessories)	WS4KHD-MSO-LICENSE
Spectrum Analyzer (2020 release)	
WaveSource Arbitrary Waveform Generator	WS4KHD-FG

Serial Trigger and Decode Options

AudioBus Trigger and Decode	WS4KHD-AUDIOBUS TD
Automotive Bundle: CAN, CAN FD, LIN, FlexRay Trigger and Decode	WS4KHD-AUTO TD
Embedded Bundle: I2C, SPI, UART-RS232 Trigger and Decode	WS4KHD-EMB TD

Power Analysis Options

Power Analysis	WS4KHD-PWR
----------------	------------

General Accessories

Softcase	WS4KHD-SOFTCASE
Rackmount Kit	WS4KHD-RACK

**Bandwidth upgrades can be made at any time.
Contact your local Teledyne LeCroy sales office.**

For more information, please contact:

ADMESS

ADMESS Vertriebs GmbH
Ernst-Kiefer-Straße 9
67292 Kirchheimbolanden /Germany

Tel.: +49 (0) 6352 / 78 99 8 - 0
Telefax: +49 (0) 6352 / 78 99 8 - 20
E-Mail: info@admess.de
www.admess.de



Product Description	Product Code
Probes	
250 MHz Passive Probe – 5 mm, 10:1, 10 MΩ	PP019
500 MHz Passive Probe – 5 mm, 10:1, 10 MΩ	PP026
1 GHz 5 KΩ 100:1 Passive Probe	PP065
Power/Voltage Rail Probe with 4 GHz bandwidth, 1.2x attenuation, ±30 V offset, ±800 mV	RP4030
RP4030 Browser Tip Accessory	RP4000-BROWSER
30 A, 50 MHz Current Probe – AC/DC, 30 Arms, 50 A peak pulse, 1.5-meter cable	CP030
30 A, 10 MHz Current Probe – AC/DC, 30 Arms, 50 A peak pulse, 3-meter cable	CP030-3M
30 A, 50 MHz High Sensitivity Current Probe – AC/DC, 30 Arms, 50 A peak pulse, 1.5-meter cable	CP030A
30 A, 100 MHz Current Probe – AC/DC, 30 Arms, 50 A peak pulse, 1.5-meter cable	CP031
30A, 100 MHz High Sensitivity Current Probe – AC/DC, 30 Arms, 50 A peak pulse, 1.5-meter cable	CP031A
150 A, 10 MHz Current Probe – AC/DC; 150 Arms; 500 A peak pulse, 2-meter cable	CP150
150 A, 5 MHz Current Probe – AC/DC, 150 Arms, 500 A peak pulse, 6-meter cable	CP150-6M
500 A, 2 MHz Current Probe – AC/DC, 500 Arms, 700 A peak pulse, 6-meter cable	CP500
Deskew Calibration Source	DCS025
700 V, 25 MHz High Voltage Differential Probe (±10, ±100)	AP031
1 kV, 25 MHz High Voltage Differential Probe	HVD3102A
1 kV, 25 MHz High Voltage Differential Probe (without tip accessories)	HVD3102A-NOACC
1 kV, 120 MHz High Voltage Differential Probe	HVD3106A
1 kV, 80 MHz High Voltage Differential Probe with 6-meter Cable	HVD3106A-6M
1 kV, 120 MHz High Voltage Differential Probe (without tip accessories)	HVD3106A-NOACC
2 kV, 120 MHz High Voltage Differential Probe	HVD3206A
2 kV, 80 MHz High Voltage Differential Probe with 6-meter Cable	HVD3206A-6M
6 kV, 100 MHz High Voltage Differential Probe	HVD3605A
High Voltage Fiber Optic Probe, 60 MHz bandwidth	HVFO103
HVFO100 Universal ±1 V Tip Accessory	HVFO100-1X-TIP-U
HVFO100 Universal ±5 V Tip Accessory	HVFO100-5X-TIP-U
HVFO100 Universal ±10 V Tip Accessory	HVFO100-10X-TIP-U
HVFO100 Universal ±20 V Tip Accessory	HVFO100-20X-TIP-U
HVFO100 Universal ±40 V Tip Accessory	HVFO100-40X-TIP-U
HVFO 1 m Optical Cable Accessory	HVFO-1M-FIBER
HVFO 2 m Optical Cable Accessory	HVFO-2M-FIBER
HVFO 6 m Optical Cable Accessory	HVFO-6M-FIBER
100:1 400 MHz 50 MΩ 1 kV High Voltage Probe	HVP120
100:1 400 MHz 50 MΩ 4 kV High Voltage Probe	PPE4KV
1000:1 400 MHz 50 MΩ 5 kV High Voltage Probe	PPE5KV
1000:1 400 MHz 5 MΩ / 50 MΩ 6 kV High Voltage Probe	PPE6KV
200 MHz, 3.5 pF, 1 MΩ Active Differential Probe, ±20 V	ZD200
500 MHz, 1.0 pF Active Differential Probe, ±8 V	ZD500
500 MHz Active Differential Probe (±1, ±10, ±100)	AP033
1 GHz, 1.0 pF Active Differential Probe, ±8 V	ZD1000
1.5 GHz, 1.0 pF Active Differential Probe, ±8 V	ZD1500
1 GHz, 0.9 pF, 1 MΩ High Impedance Active Probe	ZS1000
1.5 GHz, 0.9 pF, 1 MΩ High Impedance Active Probe	ZS1500

Probe Adapters

Tek Probe to ProBus Probe Adapter	TPA10
-----------------------------------	-------